

USER MANUAL

HYBRID SOLAR INVERTER/CHARGER

Table Of Contents

PRODUCT OVERVIEW	1
INSTALLATION	2
Unpacking and Inspection	2
Preparation	2
Mounting the Unit	2
Battery Connection	3
AC Input/Output Connection	4
PV Connection	6
Final Assembly	8
OPERATION	9
Power ON/OFF	9
Operation and Display Panel	9
LCD Setting	10
BATTERY EQUALIZATION	17
SETTING FOR LITHIUM BATTERY	19
Fault Reference Code	24
Warning Indicator	25
SPECIFICATIONS	26
Table 1 Line Mode Specifications	26
Table 2 Inverter Mode Specifications	27
Table 3 Charge Mode Specifications	28
Table 4 General Specifications	29
TROUBLE SHOOTING	30

PRODUCT OVERVIEW

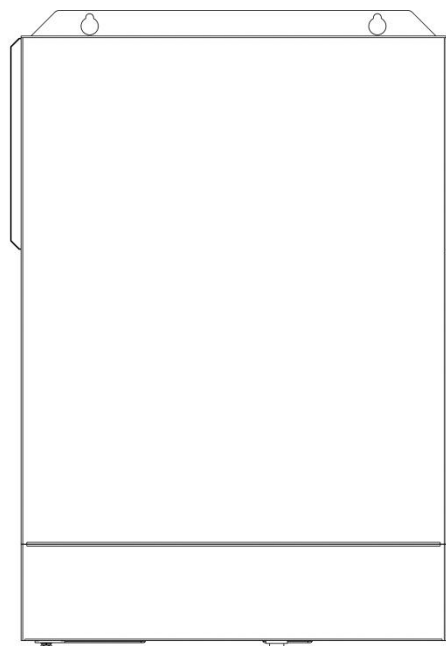
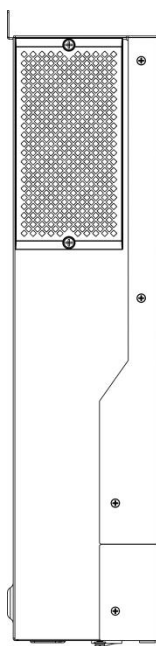

1. LCD display
2. Status indicator
3. Charging indicator
4. Fault indicator
5. Function buttons
6. Power on/off switch
7. AC input
8. AC output
9. PV input
10. Battery input
11. RS232 communication port
12. RS485 communication port
13. Wire outlet hole
14. Grounding

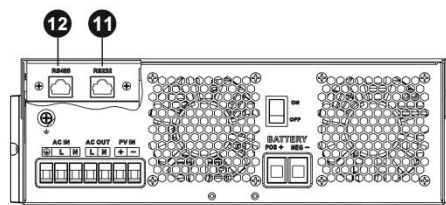
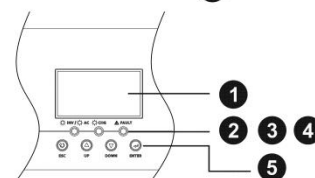
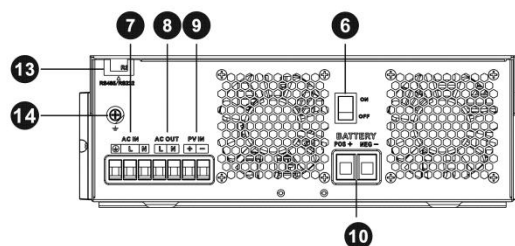

INSTALLATION

Unpacking and Inspection

Before installation, please inspect the unit. Be sure that nothing inside the package is damaged. You should have received the following items inside of package:

1. The unit x 1
2. User manual x 1

Preparation

Before connecting all wirings, please take off bottom cover by removing two screws as shown below.

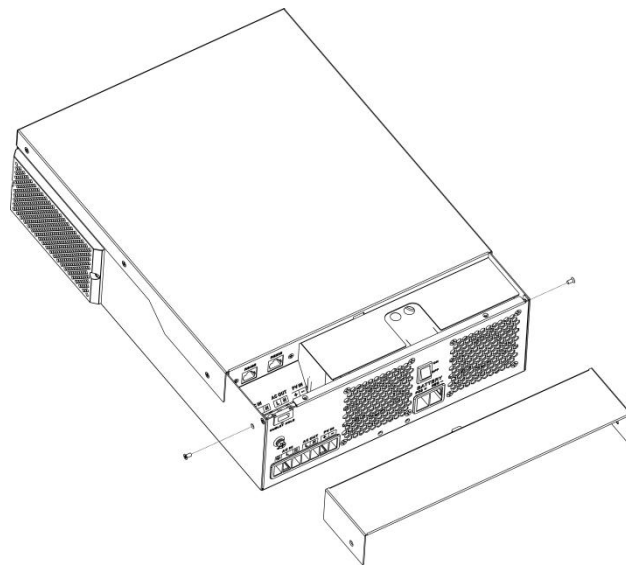

Mounting the Unit

Consider the following points before selecting where to install:

1. Do not mount the inverter on flammable construction materials.
2. Mount on a solid surface
3. Install this inverter at eye level in order to allow the LCD display to be read at all times.
4. The ambient temperature should be between 0°C and 55°C to ensure optimal operation.
5. The recommended installation position is to be adhered to the wall vertically.
6. Be sure to keep other objects and surfaces as shown in the right diagram to guarantee sufficient heat dissipation and to have enough space for removing wires.

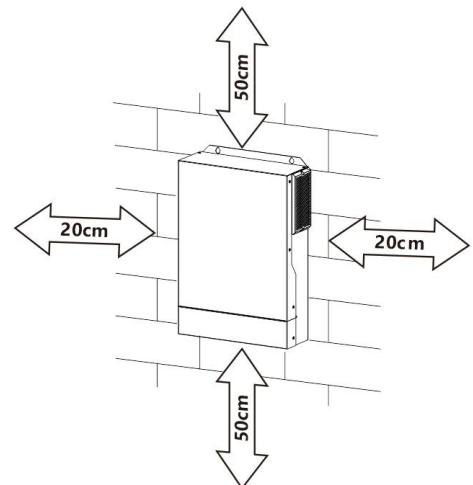

SUITABLE FOR MOUNTING ON CONCRETE OR OTHER NON-COMBUSTIBLE SURFACE ONLY.

Install the unit by screwing three screws. It's recommended to use M4 or M5 screws.

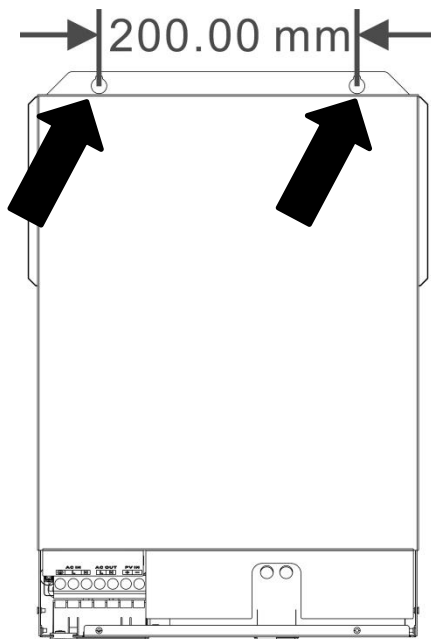

Battery Connection

CAUTION: For safety operation and regulation compliance, it's requested to install a separate DC over-current protector or disconnect device between battery and inverter. It may not be requested to have a disconnect device in some applications, however, it's still requested to have over-current protection installed. Please refer to typical amperage in below table as required fuse or breaker size.

WARNING! All wiring must be performed by a qualified personnel.

WARNING! It's very important for system safety and efficient operation to use appropriate cable for battery connection. To reduce risk of injury, please use the proper recommended cable 、stripping length(L2) and tinning length(L1) as below.

Stripping Length:

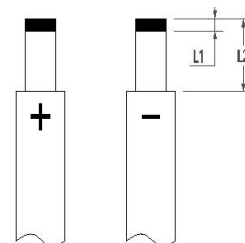

Recommended battery cable 、stripping length (L2) and tinning length(L1):

Model	Maximum Amperage	Battery capacity	Wire Size	Cable mm ²	L1 (mm)	L 2 (mm)	Torque value
3.5KVA	137A	100AH	2AWG	38	3	18	2~ 3 Nm
5.5KVA/6.2KVA	137A	200AH	2AWG	38	3	18	2~ 3 Nm

Please follow below steps to implement battery connection:

1. Remove insulation sleeve 18 mm for positive and negative cables based on recommended stripping length.
2. Connect all battery packs as units requires. It's suggested to use recommended battery capacity.
3. Insert battery cable flatly into battery connector of inverter and make sure the bolts are tightened with torque of 2-3 Nm. Make sure polarity at both the battery and the inverter/charge is correctly connected and battery cables are tightly screwed to the battery connector.

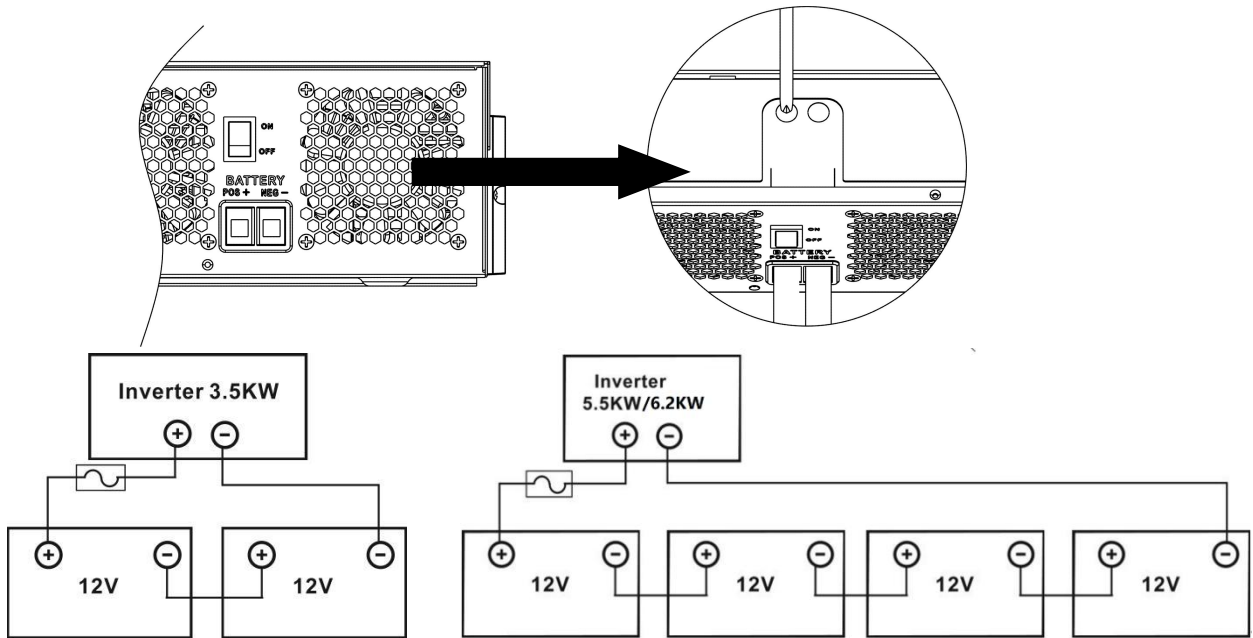

WARNING: Shock Hazard
 Installation must be performed with care due to high battery voltage in series.

CAUTION!! Do not place anything between the flat part of the inverter terminal. Otherwise, overheating may occur.
CAUTION!! Do not apply anti-oxidant substance on the terminals before terminals are connected tightly.
CAUTION!! Before making the final DC connection or closing DC breaker/disconnector, be sure positive (+) must be connected to positive (+) and negative (-) must be connected to negative (-).

AC Input/Output Connection

CAUTION!! Before connecting to AC input power source, please install a **separate** AC breaker between inverter and AC input power source. This will ensure the inverter can be securely disconnected during maintenance and fully protected from over current of AC input. The recommended spec of AC breaker is 50A. **CAUTION!!** There are two terminal blocks with "IN" and "OUT" markings. Please do NOT mis-connect input and output connectors.

WARNING! All wiring must be performed by a qualified personnel.

WARNING! It's very important for system safety and efficient operation to use appropriate cable for AC input connection. To reduce risk of injury, please use the proper recommended cable size as below.

Suggested cable requirement for AC wires

Model	Gauge	Torque Value
3.5KVA	10AWG	1.4~ 1.6Nm
5.5KVA/6.2KVA	8 AWG	1.4~ 1.6Nm

Please follow below steps to implement AC input/output connection:

1. Before making AC input/output connection, be sure to open DC protector or disconnector first.
2. Remove insulation sleeve 10mm for six conductors. And shorten phase L and neutral conductor N 3 mm.
3. Insert AC input wires according to polarities indicated on terminal block and tighten the terminal screws. Be sure to connect PE protective conductor (⊕) first.

⊕→Ground (yellow-green) L→LINE (brown or black) N→Neutral (blue)

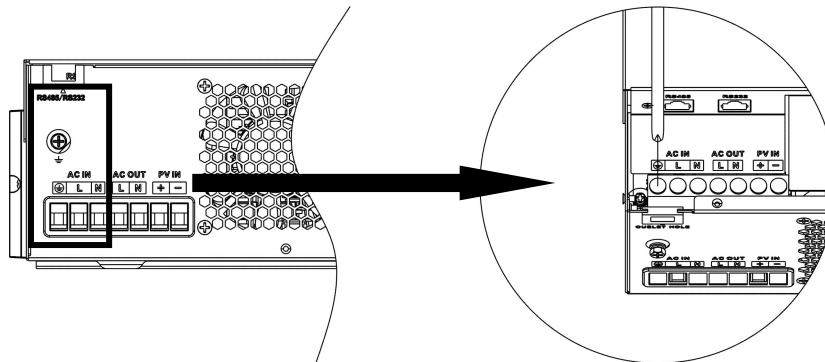

WARNING:

Be sure that AC power source is disconnected before attempting to hardwire it to the unit.

4. Then, insert AC output wires according to polarities indicated on terminal block and tighten terminal screws. Be sure to connect PE protective conductor (⊕) first.

⊕→**Ground (yellow-green)**

L→LINE (brown or black)

N→Neutral (blue)

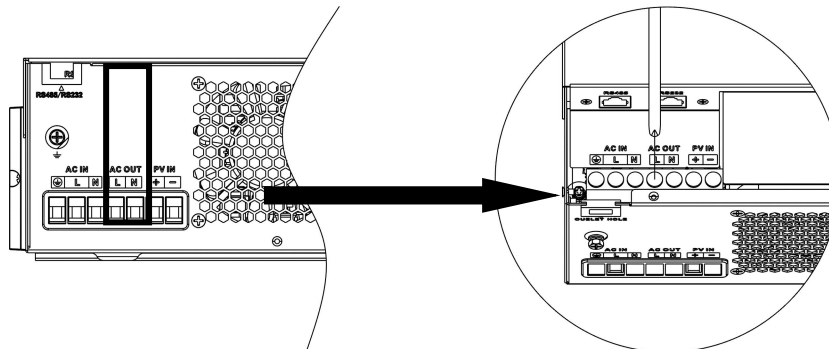

5. Make sure the wires are securely connected.

CAUTION: Important

Be sure to connect AC wires with correct polarity. If L and N wires are connected reversely, it may cause utility short-circuited when these inverters are worked in parallel operation.

CAUTION: Appliances such as air conditioner are required at least 2~3 minutes to restart because it's required to have enough time to balance refrigerant gas inside of circuits. If a power shortage occurs and recovers in a short time, it will cause damage to your connected appliances. To prevent this kind of damage, please check manufacturer of air conditioner if it's equipped with time-delay function before installation. Otherwise, this inverter/charger will trig overload fault and cut off output to protect your appliance but sometimes it still causes internal damage to the air conditioner.

PV Connection

CAUTION: Before connecting to PV modules, please install **separately** a DC circuit breaker between inverter and PV modules.

WARNING! All wiring must be performed by a qualified personnel.

WARNING! It's very important for system safety and efficient operation to use appropriate cable for PV module connection. To reduce risk of injury, please use the proper recommended cable size as below.

Model	Typical Amperage	Cable Size	Torque
3.5KVA (PVmax=160V)	40A	8 AWG	1.4~1.6 Nm
3.5KVA	15A	12 AWG	1.4~1.6 Nm
5.5KVA	18A	12 AWG	1.4~1.6 Nm
6.2KVA	27A	12 AWG	1.4~1.6 Nm

PV Module Selection:

When selecting proper PV modules, please be sure to consider below parameters:

1. Open circuit Voltage (Voc) of PV modules not exceeds max. PV array open circuit voltage of inverter.
2. Open circuit Voltage (Voc) of PV modules should be higher than min. battery voltage.

Solar Charging Mode				
INVERTER MODEL	3.5KVA	5.5KVA	6.2KVA	3.5KVA(PVmax=160V)
Max. PV Array Open Circuit Voltage	500DC			160VDC
PV Array MPPT Voltage Range	60VDC~500VDC			30-160V
Max. PV INPUT CURRENT	15A	18A	27A	50A

Take the 450Wp and 550Wp PV module as an example. After considering above two parameters, the recommended module configurations are listed in the table below.

Solar Panel Spec. (reference) - 450Wp - Vmp: 34.67Vdc - Imp: 13.82A - Voc: 41.25Vdc - Isc: 12.98A	SOLAR INPUT	Q'ty of panels	Total input power	Inverter Model
	3 pcs in serial	3 pcs	1,350 W	3.5KVA/5.5KVA/6.2KVA
	4 pcs in serial	4 pcs	1,800 W	
	5 pcs in serial	5 pcs	2,250 W	
	6 pcs in serial	6 pcs	2,700 W	
	7 pcs in serial	7 pcs	3,150 W	
	8 pcs in serial	8 pcs	3,600 W	
	9 pcs in serial	9 pcs	4,050 W	
	10 pcs in serial	10 pcs	4,500 W	5.5KVA/6.2KVA
	11 pcs in serial	11 pcs	4,950 W	
	12 pcs in serial	12 pcs	5,400 W	6.2KVA
	6 pieces in serial and 2 sets in parallel	12 pcs	5,400 W	
	8 pieces in serial and 2 sets in parallel	14 pcs	6,300 W	3.5KVA(PVmax=160V)
	1 pcs in serial	1 pcs	450W	
2 pcs in serial	2 pcs	900W		
3 pcs in serial	3 pcs	1,350 W		
Solar Panel Spec. (reference) - 550Wp - Vmp: 42.48Vdc - Imp: 12.95A - Voc: 50.32Vdc - Isc: 13.70A	SOLAR INPUT	Q'ty of panels	Total input power	Inverter Model
	3 pcs in serial	3 pcs	1,650 W	3.5KVA/5.5KVA/6.2KVA
	4 pcs in serial	4 pcs	2,200 W	
	5 pcs in serial	5 pcs	2,750 W	
	6 pcs in serial	6 pcs	3,300 W	
	7 pcs in serial	7 pcs	3,850 W	
	8 pcs in serial	8 pcs	4,400 W	5.5KVA/6.2KVA
	9 pcs in serial	9 pcs	4,950 W	
	10 pcs in serial	10 pcs	5,500 W	5.5KVA/6.2KVA
	11 pcs in serial	11 pcs	6,050 W	
	12 pcs in serial	12 pcs	6,600 W	6.2KVA
	4 pieces in serial and 2 sets in parallel	8 pcs	4,400 W	
	5 pieces in serial and 2 sets in parallel	10 pcs	5,500 W	6.2KVA
	6 pieces in serial and 2 sets in parallel	12 pcs	6,600 W	
1 pcs in serial	1 pcs	550W	3.5KVA(PVmax=160V)	
2 pcs in serial	2 pcs	1000W		
3 pcs in serial	3 pcs	1,500 W		

PV Module Wire Connection:

Please follow below steps to implement PV module connection:

1. Remove insulation sleeve 10 mm for positive and negative conductors
2. Check correct polarity of connection cable from PV modules and PV input connectors. Then, connect positive pole (+) of connection cable to positive pole (+) of PV input connector. Connect negative pole (-) of connection cable to negative pole (-) of PV input connector.

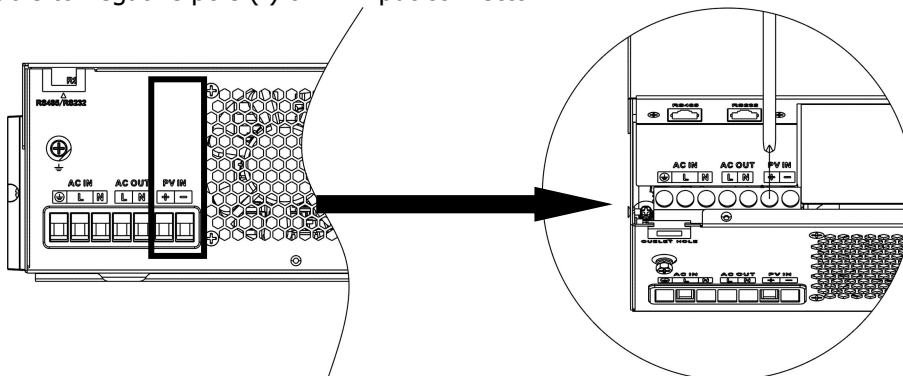
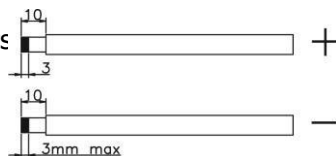

3. Make sure the wires are securely connected.

Final Assembly

After connecting all wirings, please put bottom cover back by screwing two screws as shown below.

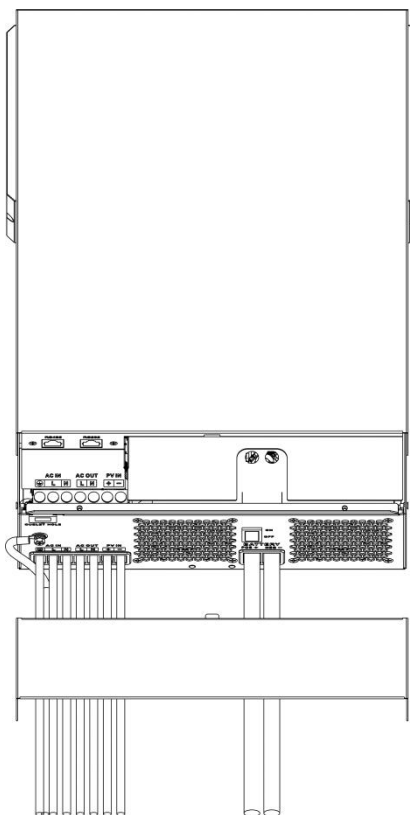

OPERATION

Power ON/OFF

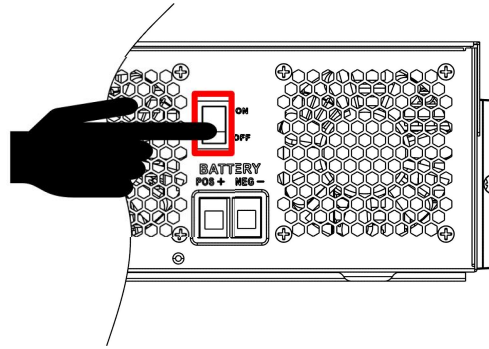

Once the unit has been properly installed and the batteries are connected well, simply press On/Off switch (located on the button of the case) to turn on the unit.

Operation and Display Panel

The operation and display panel, shown in below chart, is on the front panel of the inverter. It includes three indicators, four function keys and a LCD display, indicating the operating status and input/output power information.

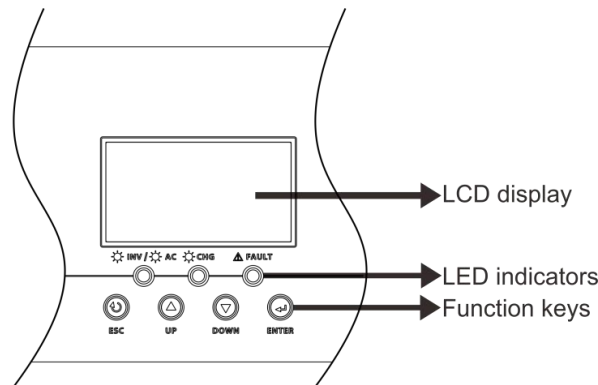

LED Indicator

LED Indicator		Messages	
AC / INV	Green	Solid On	Output is powered by utility in Line mode.
		Flashing	Output is powered by battery or PV in battery mode.
CHG	Green	Solid On	Battery is fully charged.
		Flashing	Battery is charging.
FAULT	Red	Solid On	Fault occurs in the inverter.
		Flashing	Warning condition occurs in the inverter.

Function Keys

Function Key	Description
ESC	To exit setting mode
UP	To go to previous selection
DOWN	To go to next selection
ENTER	To confirm the selection in setting mode or enter setting mode

LCD Setting

After pressing and holding ENTER button for 3 seconds, the unit will enter setting mode. Press "UP" or "DOWN" button to select setting programs. And then, press "ENTER" button to confirm the selection or ESC button to exit.

Setting Programs:









Program	Description	Selectable option	
01	Output source priority: To configure load power source priority	Solar first 01 SOL	Solar energy provides power to the loads as first priority. If solar energy is not sufficient to power all connected loads, battery energy will supply power the loads at the same time. Utility provides power to the loads only when any one condition happens: - Solar energy is not available - Battery voltage drops to either low-level warning voltage or the setting point in program 12.
		Utility first (default) 01 UTI	Utility will provide power to the loads as first priority. Solar and battery energy will provide power to the loads only when utility power is not available.
		SBU priority 01 SBU	Solar energy provides power to the loads as first priority. If solar energy is not sufficient to power all connected loads, battery energy will supply power to the loads at the same time. Utility provides power to the loads only when battery voltage drops to either low-level warning voltage or the setting point in program 12.
		SUB priority 01 SUB	Solar energy is charged first and then power to the loads. If solar energy is not sufficient to power all connected loads, Utility energy will supply power to the loads at the same time. Note: SUB priority is just for PVmax=500Vdc model.



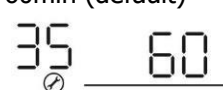
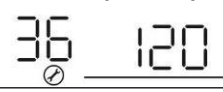

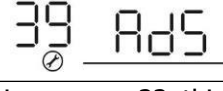
02	Maximum charging current: To configure total charging current for solar and utility chargers. (Max. charging current = utility charging current + solar charging current)	60A (default) 02 60 ^A	If selected, acceptable charging current range will be from Max. AC charging current to Max. charging current of SPEC, but it shouldn't be less than the AC charging current (program 11)
03	AC input voltage range	Appliances (default) 03 APL	If selected, acceptable AC input voltage range will be within 90-280VAC.
		UPS 03 UPS	If selected, acceptable AC input voltage range will be within 170-280VAC.
		Generator 03 Gnt	If selected, acceptable AC input voltage range will be within 170-280VAC and compatible with generators. Note: Because generators are unstable, maybe the output of inverter will be unstable too.
05	Battery type	AGM (default) 05 AGn	Flooded 05 FLd
		User-Defined 05 USE	If "User-Defined" is selected, battery charge voltage and low DC cut-off voltage can be set up in program 26, 27 and 29.
		05 LI2	Support PYLON US2000 Protocol 3.5 Version
		05 LI4	Standard communication Protocol form inverter supplier
06	Auto restart when overload occurs	Restart disable 06 Lfd	Restart enable (default) 06 LFE
07	Auto restart when over temperature occurs	Restart disable 07 tfd	Restart enable (default) 07 tFE
08	Output voltage	220V 08 220 ^v	230V (default) 08 230 ^v
		240V 08 240 ^v	

09	Output frequency	50Hz (default) 09 50 Hz	60Hz 09 60 Hz
10	Auto bypass When selecting "auto", if the mains power is normal, it will automatically bypass, even if the switch is off.	manual(default) 10 nNL	auto 10 ALO
11	Maximum utility charging current	30A (default) 11 30A If selected, acceptable charging current range will be within 2-Max. AC charging current of SPEC.	
12	Setting voltage point back to utility source when selecting "SBU priority" or "Solar first" in program 01.	48V models: 46V (default) 12 46.0 ^{BATT} v	Setting range is from 44.0V to 57.2V for 48v model, but the max setting value must be less than the value of program13.
		24V models: 23V (default) 12 23.0 ^{BATT} v	Setting range is from 22.0V to 28.6V for 24v model, but The max setting value must be less than the value of program13.
13	Setting voltage point back to battery mode when selecting "SBU priority" or "Solar first" in program 01.	Battery fully charged (default) 13 FUL ^{BATT}	48V models: Setting range is from 48V to full (the value of program26-0.4V), but the max setting value must be more than the value of program12. 24V models: Setting range is from 24V to full (the value of program26-0.4V), but the max setting value must be more than the value of program12.
16	Charger source priority: To configure charger source priority	If this inverter/charger is working in Line, Standby or Fault mode, charger source can be programmed as below:	
		Solar first 16 CSO	Solar energy will charge battery as first priority. Utility will charge battery only when solar energy is not available.
		Solar and Utility (default) 16 SNU	Solar energy and utility will charge battery at the same time.
		Only Solar 16 OSO	Solar energy will be the only charger source no matter utility is available or not.
		If this inverter/charger is working in Battery mode, only solar energy can charge battery. Solar energy will charge battery if it's available and sufficient.	

18	Buzzer mode	Mode1 bU2 18 nd1 ⊗	Buzzer mute
		Mode2 bU2 18 nd2 ⊗	The buzzer sounds when the input source changes or there is a specific warning or fault
		Mode3 bU2 18 nd3 ⊗	The buzzer sounds when there is a specific warning or fault
		Mode4(default) bU2 18 nd4 ⊗	The buzzer sounds when there is a fault
19	Auto return to default display screen	Return to default display screen (default) 19 ESP ⊗	If selected, no matter how users switch display screen, it will automatically return to default display screen (Input voltage /output voltage) after no button is pressed for 1 minute.
		Stay at latest screen 19 BEP ⊗	If selected, the display screen will stay at latest screen user finally switches.
20	Backlight control	Backlight on (default) 20 LON ⊗	Backlight off 20 LOF ⊗
23	Overload bypass: When enabled, the unit will transfer to line mode if overload occurs in battery mode.	Bypass disable 23 byd ⊗	Bypass enable(default) 23 byE ⊗
25	Modbus ID Setting	Modbus ID Setting Range : 001(default)~247 n0d 25 001 ⊗	
26	Bulk charging voltage (C.V voltage)	48V models default setting: 56.4V CU 26 56.4 ^{BATT} v ⊗	
		24V models default setting: 28.2V CU 26 28.2 ^{BATT} v ⊗	
		If self-defined is selected in program 5, this program can be set up. Setting range is from 24.0V to 30.0V for 24v model and 48.0V to 62.0V for 48v model. But the setting value must be more than or equal the value of program27. Increment of each click is 0.1V.	

27	Floating charging voltage	48V models default setting: 54.0V FLV 27 ^{BATT} 54.0 v	
		24V models default setting: 27.0V FLV 27 ^{BATT} 27.0 v	
		If self-defined is selected in program 5, this program can be set up. Setting range is from 24.0V to the value of program 26 for 24v model and 48.0V to the value of program 26 for 48v model. Increment of each click is 0.1V.	
29	Low DC cut-off voltage	48V models default setting: 42.0V COV 29 ^{BATT} 42.0 v	
		24V models default setting: 21.0v COV 29 ^{BATT} 21.0 v	
		If self-defined is selected in program 5, this program can be set up. Setting range is from 20.0V to 27.0V for 24v model and 40.0V to 54.0V for 48v model. The setting value must be less than the value of program12. Increment of each click is 0.1V.Low DC cut-off voltage will be fixed to setting value no matter what percentage of load is connected.	
32	Bulk charging time (C.V stage)	Automatically (Default): 32 AUT	If selected, inverter will judge this charging time automatically.
		5 min 32 5	The setting range is from 5 min to 900 min. Increment of each click is 5 min.
		900 min 32 900	
		If "USE" is selected in program 05, this program can be set up.	
33	Battery equalization	Battery equalization 33 EEN	Battery equalization disable (default) 33 EdS
		If "Flooded" or "User-Defined" is selected in program 05, this program can be set up.	

34	Battery equalization voltage	48V models default setting is 58.4V. Setting range is from floating voltage ~ 64V. Increment of each click is 0.1V.	
			
35	Battery equalized time	24V models default setting is 29.2V. Setting range is from floating voltage ~ 31V. Increment of each click is 0.1V.	
			
35	Battery equalized time	60min (default) 	Setting range is from 0 min to 900min.
36	Battery equalized timeout	120min (default) 	Setting range is from 0min to 900 min.
37	Equalization interval	30days (default) 	Setting range is from 1 to 90 days.
39	Equalization activated immediately	Enable 	Disable (default) 
		<p>If equalization function is enabled in program 33, this program can be set up. If "Enable" is selected in this program, it's to activate battery equalization immediately and LCD main page will shows "E9". If "Disable" is selected, it will cancel equalization function until next activated equalization time arrives based on program 37 setting. At this time, "E9" will not be shown in LCD main page..</p>	
41	Automatic activation for lithium battery		Disable automatic activation (default)
			When Program05 is selected "LIX" as lithium battery and when the battery is not detected, the unit will activate automatically the lithium battery at a time. If you want to activate automatically the lithium battery, you must restart the unit.
42	Manual activation for lithium battery		Default: disable activation
			When Program05 is selected "LIX" as lithium battery, when the battery is not detected, If you want to activate the lithium battery at a time, you could selected it.

43	Setting SOC point back to utility source when selecting "SBU priority" or "Solar first" in program 01		Default 50%, 20%~50% Settable
44	Setting SOC point back to battery mode when selecting "SBU priority" or "Solar first" in program 01		Default 95%, 60%~100% Settable
45	Low DC cut-off SOC		Default 20%, 3%~30% Settable
46	Maximum discharge current protection		Default OFF Disable current discharge current protection function
			When the discharge current exceeds setting value, the battery will stop discharging. The setting range is from 50A to 500A.

BATTERY EQUALIZATION

Equalization function is added into charge controller. It reverses the buildup of negative chemical effects like stratification, a condition where acid concentration is greater at the bottom of the battery than at the top. Equalization also helps to remove sulfate crystals that might have built up on the plates. If left unchecked, this condition, called sulfation, will reduce the overall capacity of the battery. Therefore, it's recommended to equalize battery periodically.

- **How to Apply Equalization Function**

You must enable battery equalization function in monitoring LCD setting program 33 first. Then, you may apply this function in device by either one of following methods:

1. Setting equalization interval in program 37.
2. Active equalization immediately in program 39.

- **When to Equalize**

In float stage, when the setting equalization interval (battery equalization cycle) is arrived, or equalization is active immediately, the controller will start to enter Equalize stage.

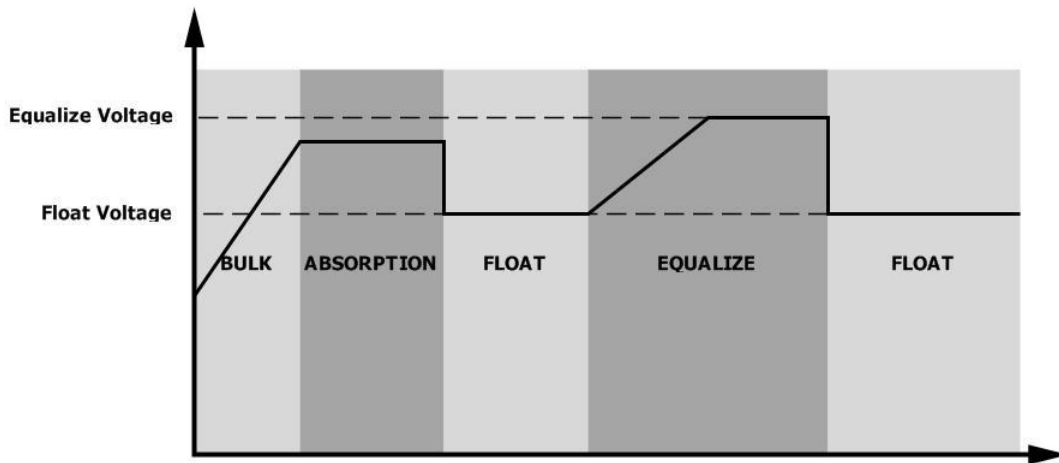

- **Equalize charging time and timeout**

In Equalize stage, the controller will supply power to charge battery as much as possible until battery voltage raises to battery equalization voltage. Then, constant-voltage regulation is applied to maintain battery voltage at the battery equalization voltage. The battery will remain in the Equalize stage until setting battery equalized time is arrived.

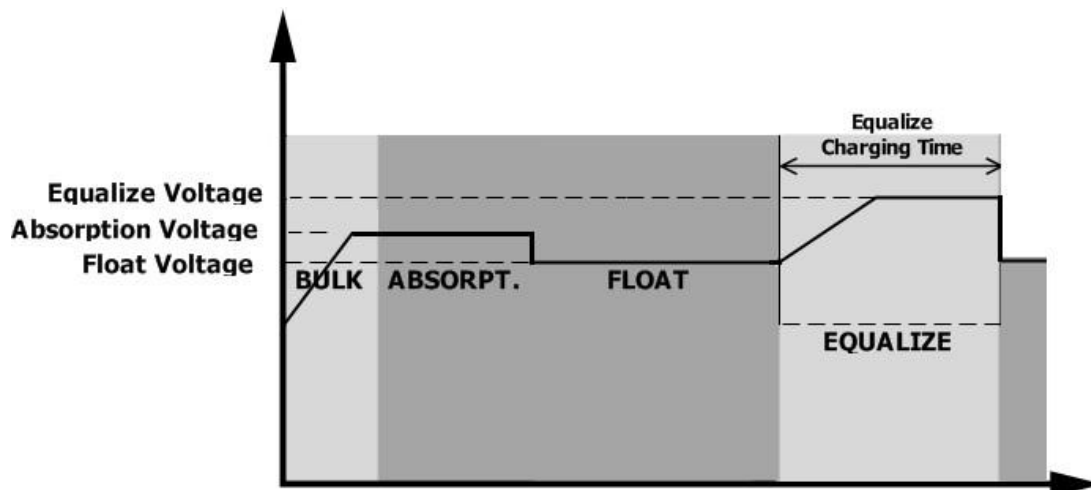

However, in Equalize stage, when battery equalized time is expired and battery voltage doesn't rise to battery equalization voltage point, the charge controller will extend the battery equalized time until battery voltage achieves battery equalization voltage. If battery voltage is still lower than battery equalization voltage when battery equalized timeout setting is over, the charge controller will stop equalization and return to float stage.

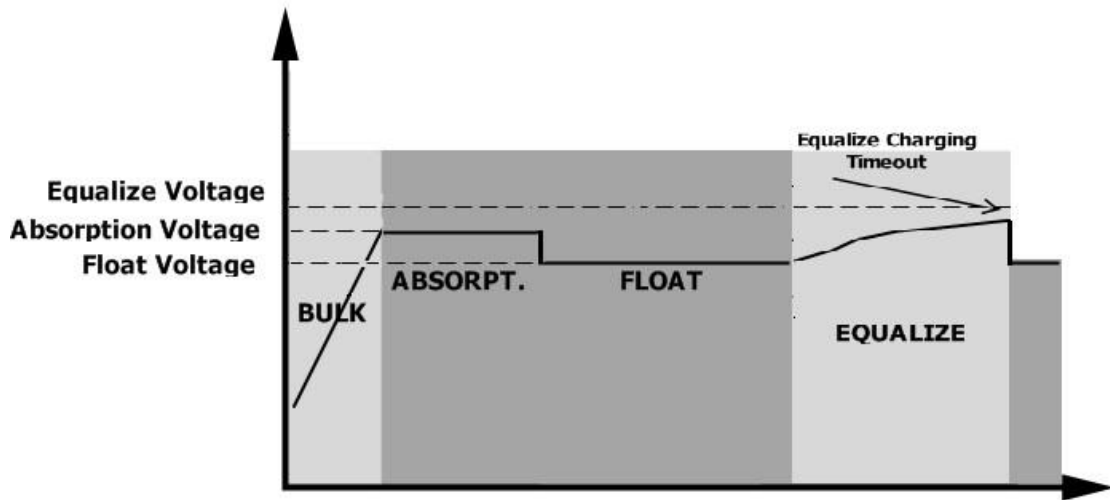

SETTING FOR LITHIUM BATTERY

Lithium Battery Connection

If choosing lithium battery for the inverter, you are allowed to use the lithium battery only which we have configured. There're two connectors on the lithium battery, RS485 port of BMS and power cable.

Please follow below steps to implement lithium battery connection:

- 1). Assemble battery terminal based on recommended battery cable and terminal size (same as Lead acid, see section Lead-acid Battery connection for details).
- 2). Connect the end of RS485 port of battery to BMS(RS485) communication port of inverter.

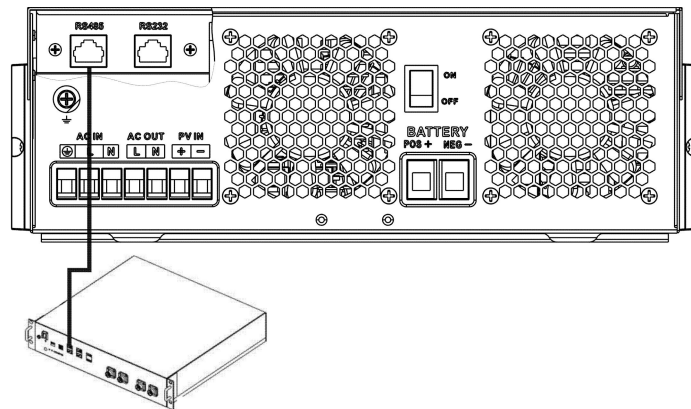

Fig 1

Lithium battery communication and setting

if choosing lithium battery, make sure to connect the BMS communication cable between the battery and the inverter. This communication cable delivers information and signal between lithium battery and the inverter. This information is listed below:

- Re-configure charging voltage, charging current and battery discharge cut-off voltage according to the lithium battery parameters.
- Have the inverter start or stop charging according to the status of lithium battery.

Connect the end of RS485 of battery to RS485 communication port of inverter

Make sure the lithium battery RS485 port connects to the inverter is Pin to Pin, the communication cable is inside of package and the inverter RS485 port pin assignment shown as below:

Pin number	RS485 Port
PIN1	RS485-B
PIN2	RS485-A
PIN7	RS485-A
PIN8	RS485-B

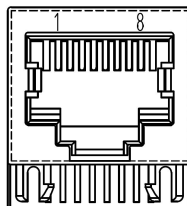

Notice: communication cable is extra optional part, if need, please contact supplier to get one.

LCD setting

After connecting, you need to finish and confirm some settings as follow:

- 1) Select program 05 as lithium battery type.
- 2) Confirm program 41/42/43/44/45 setting value.

Note: Program 43/44/45 are only available with successful communication, they will replace the Program 12/13/29 function, at the same time, program 12/13/29 become unavailable.

LCD Display

If communication between the inverter and battery is successful, there is some information showing on the LCD as follow:

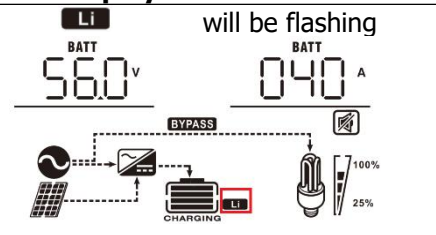
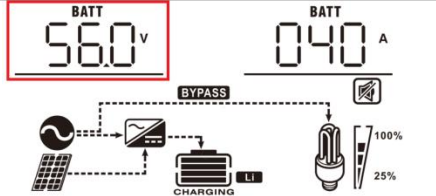
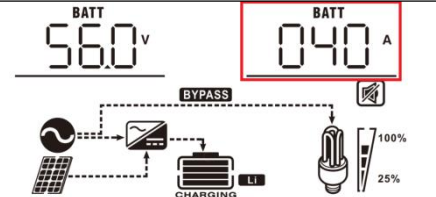
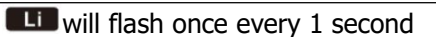
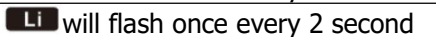
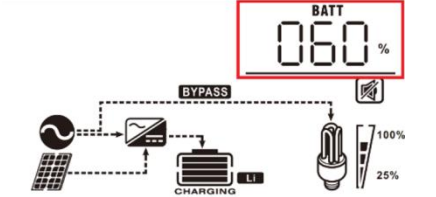
Item	Description	LCD display
1	Communication successful icon	 <p>will be flashing</p>
2	Max lithium battery charging voltage	 <p>Max lithium battery charging voltage is 56.0V.</p>
3	Max lithium battery charging current	 <p>Max lithium battery charging current is 40A.</p>
4	Lithium battery discharging is forbidden	
5	Lithium battery charging is forbidden	
6	Lithium battery SOC(%)	 <p>Lithium battery SOC is 63AH and 60%</p>

Setting for PYLON US2000 lithium battery

1). PYLONTECH US2000 lithium battery setting:

Dip Switch: There are 4 Dip Switches that sets different baud rate and battery group address. If switch position is turned to the "OFF" position, it means "0". If switch position is turned to the "ON" position, it means "1".

Dip 1 is "ON" to represent the baud rate 9600.

Dip 2, 3 and 4 are reserved for battery group address.

Dip switch 2, 3 and 4 on master battery (first battery) are to set up or change the group address.

NOTE: "1" is upper position and "0" is bottom position.

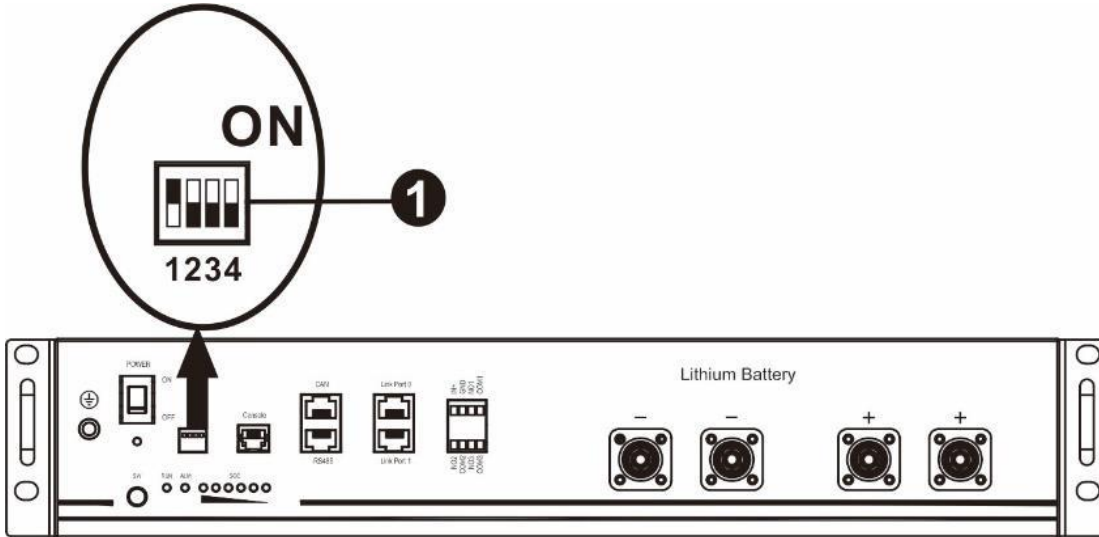

2). Process of install

Step 1. Use the RS485 cable to connect inverter and Lithium battery as Fig 1.

Step 2. Switch on Lithium battery.

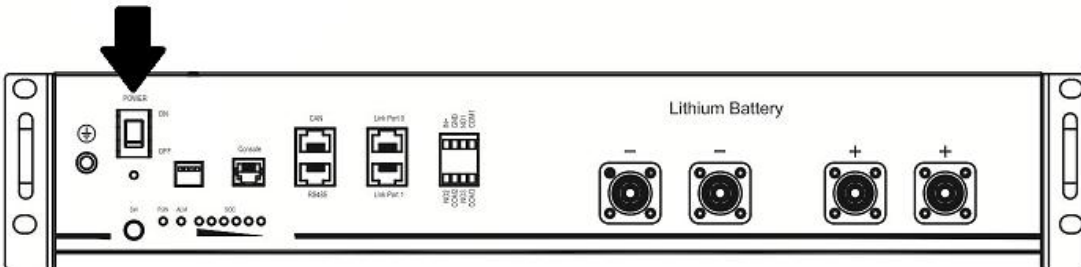

Step 3. Press more than three seconds to start Lithium battery, power output ready.

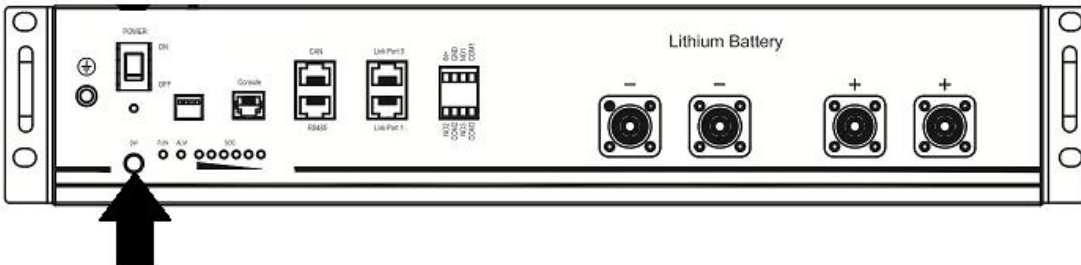

Step 4. Turn on the inverter.

Step 5. Be sure to select battery type as "Li2" in LCD program 5.

If communication between the inverter and battery is successful, the battery icon  on LCD display will light

Setting for lithium battery without communication

This suggestion is used for lithium battery application and avoid lithium battery BMS protection without communication, please finish the setting as follow:

1. Before starting setting, you must get the battery BMS specification:

- A. Max charging voltage
- B. Max charging current
- C. Discharging protection voltage

2. Set battery type as "USE" (user-defined)

05	Battery type	AGM (default) 05 AGM	Flooded 05 FLd
		User-Defined 05 USE	If "User-Defined" is selected, battery charge voltage and low DC cut-off voltage can be set up in program 26, 27 and 29.

3. Set C.V voltage as Max charging voltage of BMS-0.5V.

26	Bulk charging voltage (C.V voltage)	default setting: 56.4V CU 26 56.4 ^{BATT} v
		If self-defined is selected in program 5, this program can be set up. Setting range is from 24.0V to 31.0V for 24v model and 48.0V to 62.0V for 48v model. But the setting value must be more than or equal the value of program 27. Increment of each click is 0.1V.

4. Set floating charging voltage as C.V voltage.

27	Floating charging voltage	default setting: 54.0V FLU 27 54.0 ^{BATT} v
		If self-defined is selected in program 5, this program can be set up. Setting range is from 24.0V to the value of program 26 for 24v model and 48.0V to the value of program 26 for 48v model. Increment of each click is 0.1V.

5. Set Low DC cut-off voltage \geq discharging protection voltage of BMS+2V.

29	Low DC cut-off voltage	default setting: 42.0V COU 29 42.0 ^{BATT} v
		If self-defined is selected in program 5, this program can be set up. Setting range is from 20.0V to 27.0V for 24v model and 40.0V to 54.0V for 48v model. The setting value must be less than the value of program 12. Increment of each click is 0.1V. Low DC cut-off voltage will be fixed to setting value no matter what percentage of load is connected.

6. Set Max charging current which must be less than the Max charging current of BMS.

02	<p>Maximum charging current: To configure total charging current for solar and utility chargers. (Max. charging current = utility charging current + solar charging current)</p>	<p>60A (default) 02 60 A</p>	<p>If selected, acceptable charging current range will be within 1- Max. charging current of SPEC, but it shouldn't be less than the AC charging current (program 11)</p>
----	--	----------------------------------	---





















7. Setting voltage point back to utility source when selecting "SBU priority" or "Solar first" in program 01. The setting value must be \geq Low DC cut-off voltage+1V, or else the inverter will have a warning as battery voltage low.

12	<p>Setting voltage point back to utility source when selecting "SBU priority" or "Solar first" in program 01.</p>	<p>Available options in 48V models: 46V (default) 12 46.0^{BATT} v</p>
		<p>Available options in 24V models: 23V (default) 12 23.0^{BATT} v</p>

Remark:

1. you'd better to finish setting without turn on the inverter(just let the LCD show, no output);
2. when you finish setting, please restart the inverter.

Fault Reference Code

Fault Code	Fault Event	Icon on
01	Over temperature of inverter module	
02	Over temperature of DCDC module	
03	Battery voltage is too high	
04	Over temperature of PV module	
05	Output short circuited.	
06	Output voltage is too high.	
07	Overload time out	
08	Bus voltage is too high	
09	Bus soft start failed	
10	PV over current	
11	PV over voltage	
12	DCDC over current	
13	Over current or surge	
14	Bus voltage is too low	
15	Inverter failed (Self-checking)	
18	Op current offset is too high	
19	Inverter current offset is too high	
20	DC/DC current offset is too high	
21	PV current offset is too high	
22	Output voltage is too low	
23	Inverter negative power	

Warning Indicator

Warning Code	Warning Event	Audible Alarm	Icon flashing
02	Temperature is too High	Beep three times every second	
04	Low battery	Beep once every second	
07	Overload	Beep once every 0.5 second	
10	Output power derating	Beep twice every 3 seconds	
14	Fan blocked	None	
15	PV energy is low	Beep twice every 3 seconds	
19	Lithium Battery communication is failed	Beep once every 0.5 second	
21	Lithium Battery over current	None	
E9	Battery equalization	None	
bP	Battery is not connected	None	

SPECIFICATIONS

Table 1 Line Mode Specifications

INVERTER MODEL	3.5KVA PVmax=160V	3.5KVA	5.5KVA	6.2KVA
Input Voltage Waveform	Sinusoidal (utility or generator)			
Nominal Input Voltage	230Vac			
Low Loss Voltage	170Vac±7V (UPS) 90Vac±7V (Appliances)			
Low Loss Return Voltage	180Vac±7V (UPS); 100Vac±7V (Appliances)			
High Loss Voltage	280Vac±7V			
High Loss Return Voltage	270Vac±7V			
Max AC Input Voltage	300Vac			
Nominal Input Frequency	50Hz / 60Hz (Auto detection)			
Low Loss Frequency	40±1Hz			
Low Loss Return Frequency	42±1Hz			
High Loss Frequency	65±1Hz			
High Loss Return Frequency	63±1Hz			
Output Short Circuit Protection	Battery mode: Electronic Circuits			
Efficiency (Line Mode)	>95% (Rated R load, battery full charged)			
Transfer Time	10ms typical (UPS); 20ms typical (Appliances)			
<p>Output power derating: When AC input voltage drops to 95V or 170V depending on models, the output power will be derated.</p>				

Table 2 Inverter Mode Specifications

INVERTER MODEL	3.5KVA PVmax=160V	3.5KVA	5.5KVA	6.2KVA
Rated Output Power	3.5KVA/3.5KW		5.5KVA/5.5KW	6.2KVA/6.2KW
Output Voltage Waveform	Pure Sine Wave			
Output Voltage Regulation	230Vac±5%			
Output Frequency	60Hz or 50Hz			
Peak Efficiency	94%			
Surge Capacity	2* rated power for 5 seconds			
Nominal DC Input Voltage	24Vdc		48Vdc	
Cold Start Voltage	23.0Vdc		46.0Vdc	
Low DC Warning Voltage Just for AGM and Flooded @ load < 20% @ 20% ≤ load < 50% @ load ≥ 50%	22.0Vdc 21.4Vdc 20.2Vdc		44.0Vdc 42.8Vdc 40.4Vdc	
Low DC Warning Return Voltage Just for AGM and Flooded @ load < 20% @ 20% ≤ load < 50% @ load ≥ 50%	23.0Vdc 22.4Vdc 21.2Vdc		46.0Vdc 44.8Vdc 42.4Vdc	
Low DC Cut-off Voltage Just for AGM and Flooded @ load < 20% @ 20% ≤ load < 50% @ load ≥ 50%	21.0Vdc 20.4Vdc 19.2Vdc		42.0Vdc 40.8Vdc 38.4Vdc	

Table 3 Charge Mode Specifications

Utility Charging Mode				
INVERTER MODEL	3.5KVA PVmax=160V	3.5KVA	5.5KVA	6.2KVA
Max Charging Current (PV+AC) (@ VI/P=230Vac)	120Amp	100Amp	100Amp	120Amp
Max Charging Current (AC) (@ VI/P=230Vac)	80Amp			
Bulk Charging Voltage	Flooded Battery	29.2Vdc		58.4Vdc
	AGM / Gel Battery	28.2Vdc		56.4Vdc
Floating Charging Voltage	27Vdc		54Vdc	
Overcharge Protection	33Vdc		63Vdc	
Charging Algorithm	3-Step			
Charging Curve	<p>The graph illustrates the 3-step charging process. The left y-axis represents Battery Voltage per cell, with values 2.43Vdc (2.35Vdc) and 2.25Vdc. The right y-axis represents Charging Current as a percentage of the maximum, with markers at 50% and 100%. The x-axis represents Time, divided into three phases: Bulk (Constant Current), Absorption (Constant Voltage), and Maintenance (Floating). The transition from Bulk to Absorption occurs at time T0, and the transition from Absorption to Maintenance occurs at time T1. A note specifies T1 = 10 * T0, with a minimum of 10 minutes and a maximum of 8 hours.</p>			
Solar Input				
INVERTER MODEL	3.5KVA PVmax=160V	3.5KVA	5.5KVA	6.2KVA
Rated Power	1500W	4000W	5500W	6500W
Max. PV Array Open Circuit Voltage	160Vdc	500Vdc		
PV Array MPPT Voltage Range	30Vdc~160Vdc	60Vdc~500Vdc		
Max. Input Current	50A	15A	18A	27A
Max. Charging Current(PV)	60A	100A	100A	120A

Table 4 General Specifications

INVERTER MODEL	3.5KVA PVmax=160V	3.5KVA	5.5KVA	6.2KVA
Safety Certification	CE			
Operating Temperature Range	-10°C to 55°C			
Storage temperature	-15°C~ 60°C			
Humidity	5% to 95% Relative Humidity (Non-condensing)			
Dimension(D*W*H), mm	358x295x105		438x295x105	
Net Weight, kg	6.2		8.2	8.7

TROUBLE SHOOTING

Problem	LCD/LED/Buzzer	Explanation / Possible cause	What to do
Unit shuts down automatically during startup process.	LCD/LEDs and buzzer will be active for 3 seconds and then complete off.	The battery voltage is too low	1. Re-charge battery. 2. Replace battery.
No response after power on.	No indication.	1. The battery voltage is far too low. 2. Battery polarity is connected reversed.	1. Check if batteries and the wiring are connected well. 2. Re-charge battery. 3. Replace battery.
Mains exist but the unit works in battery mode.	Input voltage is displayed as 0 on the LCD and green LED is flashing.	Input protector is tripped	Check if AC breaker is tripped and AC wiring is connected well.
	Green LED is flashing.	Insufficient quality of AC power. (Shore or Generator)	1. Check if AC wires are too thin and/or too long. 2. Check if generator (if applied) is working well or if input voltage range setting is correct. (UPS→Appliance)
	Green LED is flashing.	Set "Solar First" as the priority of output source.	Change output source priority to Utility first.
When the unit is turned on, internal relay is switched on and off repeatedly.	LCD display and LEDs are flashing	Battery is disconnected.	Check if battery wires are connected well.
Buzzer beeps continuously and red LED is on.	Fault code 07	Overload error. The inverter is overload 110% and time is up.	Reduce the connected load by switching off some equipment.
	Fault code 05	Output short circuited.	Check if wiring is connected well and remove abnormal load.
	Fault code 02	Internal temperature of inverter component is over 100°C.	Check whether the air flow of the unit is blocked or whether the ambient temperature is too high.
	Fault code 03	Battery is over-charged.	Return to repair center.
		The battery voltage is too high.	Check if spec and quantity of batteries are meet requirements.
	Fault code 06/22	Output abnormal (Inverter voltage below than 190Vac or is higher than 260Vac)	1. Reduce the connected load. 2. Return to repair center
	Fault code 08/09/15	Internal components failed.	Return to repair center.
	Fault code 13	Over current or surge.	Restart the unit, if the error happens again, please return to repair center.
	Fault code 14	Bus voltage is too low.	
Another fault code		If the wires is connected well, please return to repair center.	

